



# Containment Systems for Critical Applications



# Containment Filtration Systems

- Designed, developed, and manufactured to exact standards for control of dangerous, toxic, or noxious contaminants
- Specializing in the design, manufacturing, and testing of complete custom filtration systems
- Detailed engineering ensures compatibility and maximum operating efficiency of all equipment
- Customized manufacturing to match technical requirements
- Simplified installation with responsibility from the inlet to the outlet of the system
- AAF Flanders is responsible for each component in the system, and can, therefore, guarantee a reliable, efficient system



## Containment Filtration

All AAF Flanders products are designed, developed, and manufactured to exact standards for control of dangerous, toxic, or noxious contaminants. AAF Flanders provides equipment and services for the Department of Energy, the Department of Defense, hospitals, pharmaceutical, genetic, and biotech facilities, universities, and nuclear power and materials processing facilities. We also provide filtration equipment for customers with general ventilation requirements.

Containment systems are very high quality, high efficiency systems used to filter and contain dangerous particulate and/or gaseous contaminants. In addition to manufacturing standard components, AAF Flanders specializes in the design, manufacturing, and testing of complete custom filtration systems. Detailed engineering ensures compatibility and maximum operating efficiency of housings, blower/motor assemblies, dampers, transitions, plenums, test ports, instrumentation, and other equipment.

Customized manufacturing of total filtration systems allows AAF Flanders to match components accurately to airflow rate and capacity, residence time, and other technical requirements. Installation of the system is also simplified, since a single manufacturer has responsibility from the inlet to the outlet of the system.

AAF Flanders manufactures new adsorbers and refills spent adsorbers to meet original equipment specifications. AAF Flanders can also provide in-place testing and radioiodine testing services.

Most AAF Flanders customers prefer this single source, total system approach. AAF Flanders is responsible for each component in the system, and can, therefore, guarantee a reliable, efficient system.

# Containment Filtration Systems

## Containment Housings

**Fluid Seal** – The Fluid Seal containment housings are typically used in critical processes where dangerous airborne particulate, or gases must be prevented from entering the atmosphere.

**BF Series:** The BF Series bag-in/bag-out gel seal housing is a side servicing filter housing that has been designed to meet the air filtration needs of industries and research facilities that handle dangerous or toxic biological, radiological, or carcinogenic materials. The BF Series housing features a side access bag-in/bag-out port that allows contaminated filters or carbon adsorbers to be removed from the housing without direct contact with service personnel.

**KF Series:** The KF Series non-bag-in/bag-out gel seal housings are used in industries and research facilities concerned with filtration of potentially hazardous airborne particulates or gases that have the need for a high quality, high efficiency filtration system, but do not need a system that includes the bag-in/bag-out feature. The KF Series housing is designed for applications in which the bag-in/bag-out procedure is not necessary for filter changeout, but still require high quality side servicing filter housings.

**G Series:** The G Series housing is designed for single filter replacement from the top of the unit. A mounting stand, or some other means of support, should be used for side access installation. There is no specific diameter for inlet and outlet connections for the housing, since requirements vary considerably. The purchaser should specify the required pipe sizes and lengths. Inlet and outlet connection can be a standard rolled stainless steel sheet metal nipple or optional stainless steel piping. The G Series round bag-in/bag-out gel seal housing is designed for the installation of a single HEPA filter or carbon adsorber in low CFM ventilation systems.

**Gasket Seal** – The Gasket Seal containment housings are typically used in critical processes where dangerous airborne particulate or gases must be prevented from entering the atmosphere.

**BG Series:** The BG Series bag-in/bag-out gasket seal housing is like the BF Series housing, except that it uses the gasket seal design filter sealing method. The BG Series housing features a side access bag-in/bag-out port, which allows filters or carbon adsorbers that have been contaminated in service to be removed from the housing without direct contact with service personnel.

**KG Series:** The KG Series non-bag-in/bag-out gasket seal housing is like the KF Series housing, except that it uses the gasket seal design. The KG Series housing is designed for applications in which the bag-in/bag-out procedure is not

necessary for filter changeout, but high quality side servicing filter housings are still required.

**G Series:** The G Series housing is designed for single filter replacement from the top of the unit. A mounting stand, or some other means of support, should be used for side access installation. There is no specific diameter for inlet and outlet connections for the housing, since requirements vary considerably. The purchaser should specify the required pipe sizes and lengths. Inlet and outlet connection can be a standard rolled stainless steel sheet metal nipple or optional stainless steel piping. The G Series round bag-in/bag-out gasket seal housing is designed for the installation of a single HEPA filter or carbon adsorber in low CFM ventilation systems.

## Housing Configurations

- Axial Flow
- Radial Flow
- Remotely Operated Hot Cell
- Engineered Safety Feature (ESF) Housings & Non-ESF Housings

## High Pressure Housings

AAF Flanders produces a complete line of bag-in/bag-out designed high pressure systems manufactured from unpainted 14 and 11-gage type 304 stainless steel. Standard housings can be reinforced to withstand pressures up to 6 Pounds per Square Inch Gage (PSIG). For higher pressure, the housings are adequately reinforced to withstand positive 15 PSIG and negative 14.5 PSIG. These housings are cylindrical with a lid-type door on the top held in place by tie-down latches. The latches are manufactured so that they pivot away from the bag-in/bag-out port after release and do not impede the bag-in/bag-out process. For safety, if the design pressure is greater than positive or negative 7 PSIG, the door is held in place by bolted and gasketed flanges located on the door and housing. The inlet and outlet connections are rolled and seam-welded nipple connection sizes up to 12" long, or as specified by the design professional.

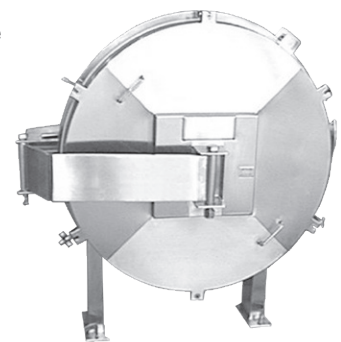

Door Hinge Mounting Legs

For round systems, as air enters the housing, a baffle plate turns the air downward. At the point where air hits the bottom of the housing, the air turns upwards and passes through the filter element. After passing through the filter element, the air hits the top of the housing and is turned again, thus forcing the air out of the filter housing. To accommodate fluid seal filters, the housing incorporates a knife-edge that mates into the gel filled perimeter channel on the face of the filter. Access to the filters is from the top or side of the housing, depending on the mounting arrangement. Prior to leaving the factory, each knife-edge is checked with an alignment gage to ensure proper orientation with the filter. Filter sealing clamps are operated through the change-out bag. Spring loaded filter clamps on the housing secure the filter during operation. Clamps—two are required on CCF and four on GGF size housings—are constructed of type 304 stainless steel with a stainless steel rod handle.



Mounting Stand

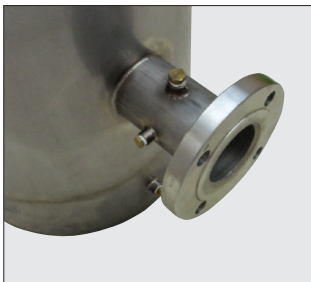

150 Lbs. Flange Test Port – Static Pressure Tap Drain Port



1/4 Thick Plate Flange – Static Pressure Tap

## Isolation Dampers

The bubble-tight isolation dampers are AAF Flanders top-of-the-line dampers. These dampers were specifically designed to provide cost-effective isolation of filter banks with high volumes of air. Each bubble-tight damper is leak tested at the factory to ensure a “bubble-tight” seal at a differential pressure of 10 inches water gage. Isolation dampers are available with the standard manual actuator or optional electric or pneumatic actuators.

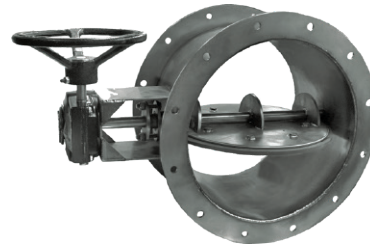

Round Bubble-Tight Damper – Used for isolation of a filter or a filter bank. This damper can also be used as a non-modulating control damper.

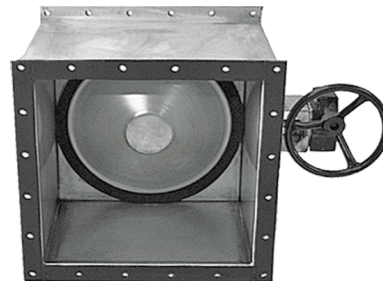

Square Bubble-Tight Damper – Used for isolation of a filter or a filter bank primarily during the filter changeout process.

# Adsorbers and Filters

## General Design Considerations

AAF Flanders provides a complete line of prefilters, as well as HEGA and HEPA filter products, with our Containment systems. When selecting the proper filtration system for your critical application, it is important to consider the following:

- Protection of maintenance personnel during filter changeout
- Particulate filtration must be provided upstream to prevent the adsorber from trapping particulates
- Some applications require high efficiency or HEPA filters located downstream of the adsorber to collect any fines (dust which might be contaminated) and to act as a backup
- Filter trains can be easily constructed with any combination of roughing filters, high efficiency filters, HEPA filters, and adsorbers
- An in-place test of both adsorbers and HEPA filters is recommended to validate the installed system
- The filtration system must be manufactured under a quality assurance program that is compliant to nationally recognized standards



Custom Design BF Series  
with Isolation Dampers and Gages



AAF Flanders provides a complete line of prefilters, HEGA, and HEPA filters with our containment systems

## High Efficiency Particulate Air (HEPA) Filters

AAF Flanders has the most complete line of HEPA filters available. We offer many choices in frame materials, size, efficiency, testing criteria, temperature rating, and airflow capacity, and supply the highest quality HEPA filters to the most demanding customers throughout the world. HEPA filters are tested in accordance with IEST-RP-CC001 for HEPA and ULPA filters.

## High Efficiency Gas Adsorbers (HEGA)

HEGAs are most often used for containment of toxic gases in air filtration systems, collecting gaseous contaminants from an airstream through adsorption. With a properly designed system, any adsorbable contaminant can be filtered and contained. All HEGAs are factory tested to a minimum mechanical efficiency of 99.9 percent.

# In-Place Testing

## In-Place Overall Efficiency Testing

Many filter systems are associated with critical applications. A critical application is one that uses material that could be harmful to the health of personnel. Regulatory agencies often mandate in-place testing as a prerequisite before the critical filter system becomes operational.

Most installed filter systems are in-place tested per ASME N510 – Testing of Nuclear Air Treatment Systems and/or AG-1 – Code on Nuclear Air & Gas Treatment. In-place testing determines if there is bypass around the HEPA filters or carbon adsorbers. These in-place testing procedures require that the filter system meets a series of pretests to ensure testability. Procedures are as follows:

1. After the pretests are completed, a challenge agent is injected upstream of the HEPA filter(s) or carbon adsorber(s).
2. Upstream and downstream concentrations are determined and a system penetration is calculated.
3. The penetration is compared to the acceptance criteria.

The system either passes and is operational, or it fails and requires corrective action.

AAF Flanders manufactures in-place test sections that allow testing to ASME N510 and AG-1 standards when there are space restrictions, or when isolation of a leaking filter is required.

**Three types of efficiency test sections are available:**

- Inlet – upstream of filter banks to introduce, mix, and sample aerosol or vapor challenge in the airstream for the first bank of filters.
- Combination – middle test sections are designed for systems that have multiple banks of filters. In this location between banks of filters the test sections will sample the penetrant in the air for the upstream bank of filters and introduce challenge for the downstream bank of filters. Single point sampling is provided for both incoming and exiting air.
- Outlet – downstream test sections provide for single, point sampling of penetration of the preceding filter bank.

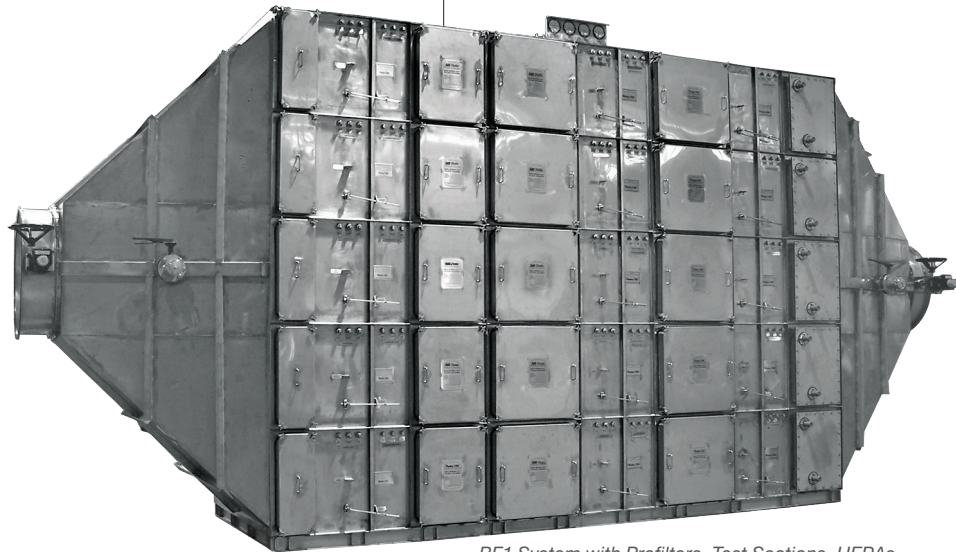

*BF1 System with Prefilters, Test Sections, HEPA's, Transitions, Carbon Adsorbers, and Dampers*

# In-Place Testing

## In-Place PrecisionScan

In-place acceptance or surveillance testing of standard HEPA filters, after the filters have been installed, is a common requirement for users of HEPA filter systems. This in-place testing is necessary to ensure that an installed filtration system meets minimum specified filtering efficiencies.

Many HEPA filter systems are associated with critical applications. However, a filter system can have some penetration and still meet the system acceptance criteria. This penetration may be due to a 'pinhole' in the filter media, for example. If a leak is a large one, the filter will have unacceptable gross penetration. But if the leak is small enough, any penetration will be diluted by surrounding clean air, and the leak will remain undetected.

The material used in some laboratories is so dangerous that the

overall efficiency in-place leak test method alone may therefore not be adequate. That is, any leaks, no matter how small, are unacceptable. The capability to detect and accurately locate pinhole leaks is clearly imperative. Scan testing with the use of AAF Flanders PrecisionScan Test Sections, provides this capability.

Some types of HEPA filters are routinely scan tested during factory production tests to locate pinhole leaks. Installations such as cleanrooms customarily use the scan test as an acceptance test. Scan testing, with the use of AAF Flanders PrecisionScan Test Sections, will also locate pinhole leaks in filters installed in side access filter housings.



*A variety of sizes are available for a wide range of airflows.*



# Custom Engineered Containment Systems

## Custom Engineered Systems

AAF Flanders can design, build, and test custom air filtration systems for specific applications, using one or more of AAF Flanders' standard products.

We have built these systems to accommodate 10 CFM to a high of 36,000 CFM, with design pressures from our standard 10 inches water gage up to 15 PSI (415 inches water gage).

AAF Flanders air filtration systems are manufactured to meet the requirements of the customer's specifications, including: blowers, outlet stacks, skids, seismic qualification, upflow and downflow arrangements, heaters, chillers, and insulation. Complete control and instrumentation packages can be engineered and factory assembled to provide the customer with a turnkey system. All system connections are manufactured to facilitate installation into the customer's process.

Customized manufacturing of total filtration systems allows AAF Flanders to match components accurately to the airflow rate and capacity, residence time, and other technical requirements. Installation of the system is also simplified, since a single manufacturer has responsibility from the inlet to the outlet of the system. We have manufactured products specified to meet Engineered Safety Feature (ESF) Systems and Non-ESF Systems in accordance with the requirements of 10 CFR 50 Appendix B.

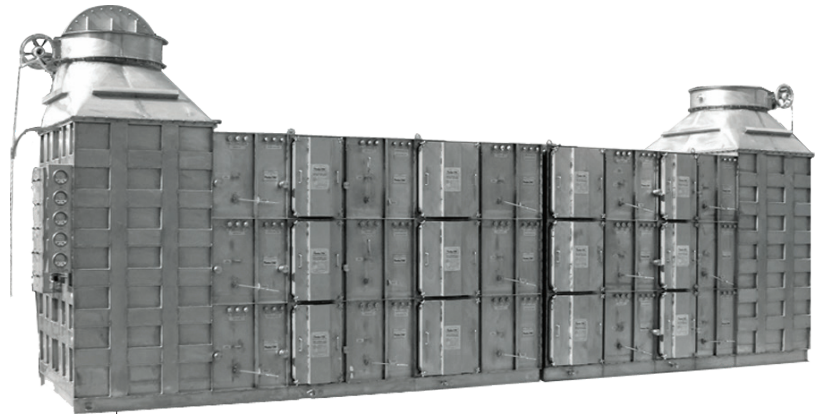

*Custom Engineered CBR Filter System with Prefilter, HEPA, and HEGA Filtration*

## Self-Contained Systems—Designed to Address CDC Guidelines

The primary function of an Airborne Infection Isolation Room (All Room) is to protect healthcare workers and the public by decreasing the likelihood that infectious diseases will be transmitted within healthcare settings. Because much of the transmission can be attributed to the close proximity between patient and hospital staff, the Centers for Disease Control (CDC) have issued guidelines for ventilation of isolation rooms and Intensive Care Units (ICUs).

The guidelines recommend that isolation rooms and ICUs have at least six air changes per hour and that both be maintained under negative pressure. Isolation room air should be exhausted to the outdoors in a way that minimizes any possible exposure to the public. To safely exhaust the air, it should first be properly filtered. Air in ICUs may be recirculated after it has passed through a properly designed HEPA filter system. The guidelines also provide procedures for the safe removal and disposal of the contaminated HEPA filters to prevent further infection.

The proper means of providing ventilation for the isolation rooms and ICUs is to furnish a dedicated filtration system for each room. AAF Flanders self-contained systems are designed to address the CDC's guidelines by providing small, high efficiency filtration systems that provide for safe changeout of filters by using bag-in/bag-out housings.

AAF Flanders systems are perfectly suited for removal of infectious airborne particles, including Multi Drug-Resistant (MDR) organisms and other viral and bacterial pathogens, such as TB, SARS, and Avian Influenza. These designed systems work well in any application requiring HEPA filtration.

# Custom Engineered Containment Systems

## Options

- Weather covers (for housing and fan) – necessary if system is to be installed outdoors.
- No-loss outlet stack – practical option if system is to be located outdoors without downstream ductwork.
- Inlet isolation damper – for control of airflow, if desired, and for isolation during filter changeout (available with manual or automatic actuator).
- Inlet transition – aids in attachment to ductwork, necessary if damper is to be installed directly upstream of the housing.
- Larger systems – contact the AAF Flanders factory or a representative for complete information.
- Fans – many fan sizes and configurations are available, such as direct drive or belt drive. Sound attention is also available.
- Separate access door – for prefilter section.
- Gel or gasket – seal design.



*BG Series SC-1000 with Optional No-loss Stack*

## Chemical, Biological, & Radioactive (CBR) Filtration Systems

A CBR filtration system is designed to provide protection against chemical, biological, and radioactive warfare agents. High quality bag-in/bag-out filter housings typically contain prefilters and High Efficiency Particulate Air (HEPA) filters to control contaminants, such as micro-organisms, viruses, and radioactive particles. The system also houses a High Efficiency Gas Adsorber (HEGA) with a special carbon to control the gas and vapor phase contaminants.

## American Society of Mechanical Engineers (ASME) Section IX Welding

All welding procedures, welders, and welder operators are qualified in accordance with ASME Boiler and Pressure Vessel Code, Section IX. All production welds are visually inspected per AAF Flanders Standard Work Instruction WI-03-022, Visual Inspection of Welds, which incorporates the workmanship acceptance criteria described in Sections 5 and 6 of ANSI/AWS D9.1 Welding Code—Specifications for Welding Sheet Metal.



*ASME, Section IX Qualified Welder Working on a Bag-in/ Bag-out Filter Housing*

## Startup Support Service Package

AAF Flanders' Startup Support Service package is designed to ensure that the highest quality products and services are provided to our customers.

### We're There for You

On-site support by AAF Flanders factory trained personnel.

### Peace of Mind

Assurance that products have been installed correctly and are ready for operation.

### We'll Show You How

Training for your personnel to ensure their understanding of proper handling, care and maintenance of AAF Flanders' air filtration and containment products.

### Take it With You

Transferable 3-year extended warranty that goes wherever the product goes.



*Dual Stage  
Containment System*

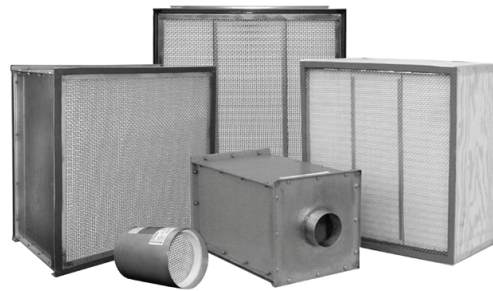

*Nuclear and Biological  
Grade Filters*

## AAF Flanders

For over 40 years, AAF Flanders has been the prime manufacturer of HEPA and HEGA containment systems for the most advanced military, pharmaceutical, hospital, and biotech lab facilities.

AAF Flanders sets the standard for the control of nuclear, biological, pharmaceutical, and chemical airborne hazards.

Our company's developments have led to dramatic improvements in bag-in/bag-out housings, remote in-place filter testing capabilities, remotely operated hot cell housings, low leak and bubble-tight isolation damper systems, seismic qualification, and the use of gel seal and gasket seal techniques.

AAF Flanders products have established the benchmark for conscientious design in quality containment air filtration.



*AAF Flanders Laminar Flow Wall  
Pharma Containment System*

## Proven Expertise of AAF Flanders

AAF Flanders offers the most comprehensive air filtration portfolio in the industry. Each product is carefully designed, manufactured, and tested in full compliance with all applicable standards to meet the most challenging demands.

Contact your local AAF Flanders representative for a complete list of AAF Flanders Air Filtration Product Solutions.

**888.223.2003**  
**aafintl.com**



Bringing clean air to life.®

9920 Corporate Campus Drive, Suite 2200, Louisville, KY 40223-5690  
888.223.2003 Fax 888.223.6500 | aafintl.com

AAF Flanders has a policy of continuous product research and improvement. We reserve the right to change design and specifications without notice.

©2023 AAF International and its affiliated companies.

ISO Certified Firm

CSP-1-100A 03/23